



VALGRO INDIA LIMITED

www.brushingmachine.com

Valgro-Hyzer

Xpert in metal preparation

Duklean

Clean Air Equipment, s

Valgro

Valgro-FynexTM

superlative surface solutions

11 Way Of deburring Sheet Metal Parts

We have wide range of deburring and Finishing machine for sheet metal parts with the One roof Solution Provider. Valgro Deburring and edge rounding machine Available with brush or belt grinding process. As well as combination of belt and brush.

Base on customer need and budget we can make customize setup to satisfy end user. Our deburring machine suitable for laser cut, press punch, plasma, and sear cut sheet metal parts.

Valgro-Hyzer
Xpert in metal preparation

Duklean
Clean Air Equipment,s *Valgro*

Valgro-FynexTM
superlative surface solutions

1. Valgro Fabrika Series Deburring Machine

Removal of vertical burrs from laser, die and water jet cut parts. Flat parts and parts that can be placed flat.
 Stainless steel, steel, aluminium, copper, etc. fine burrs removal and finishing in one pass on Optimum ease of use.

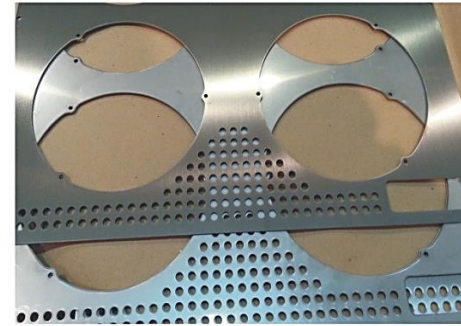

Name	Technology	Scope Of Work	Burr Classification	Working Thickness	Material Specification
Fabrika	Roller Brush	Deburring + Finishing + Cleaning	Class #1 Class #2	0.8mm - 3mm	laser cut and fine blanking press punch sheet metal cut parts

Available Mode

DB24E,
 DB24HD,
 DB32E,
 DB32HD,
 DB50HD
 DB62HD

2. Valgro Disc Edge Breaker



Removal of vertical burrs from punch, laser, and water jet cut parts. Stainless steel, steel, aluminium, copper, etc. Edge breaking deburring of metal with an abrasive brush. Incredibly low operating costs and a high production capacity

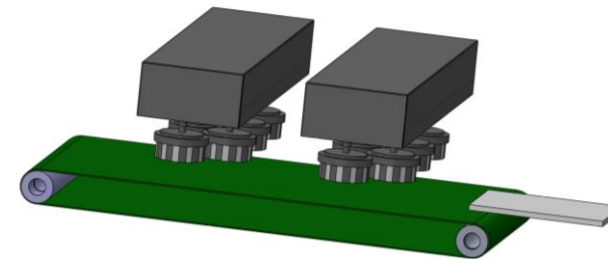

Available Mode

Name	Technology	Scope Of Work	Burr Classification	Working Thickness	Material Specification
Disc Expert	Disc Brush	Deburring + Roughening + Edge rounding	Class #1 Class #2	Up to 100mm	laser cut & Fine Blanking Sheet Metal parts

DEB-06
DEB-14
DEB-32
DEB-50
DEB-62

3. Valgro LBF Karam

Removal of vertical burrs from punch, laser, cut parts. Stainless steel, steel, aluminium, etc. Edge breaking deburring of metal with an abrasive belt and brush. Exceptionally low operating costs and a high production capacity

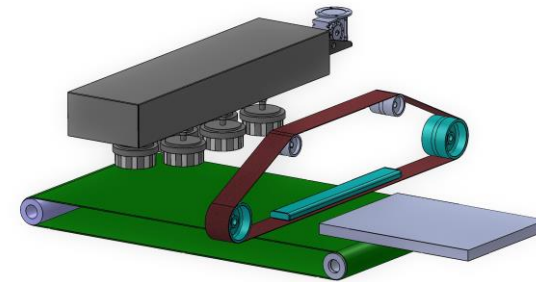
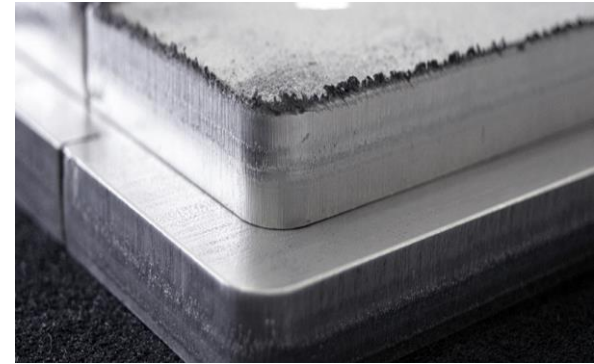

Technology	Scope Of Work	Burr Classification	Working Thickness	Material Specification	Application	Available Mode	
Cross Belt + Disc Brush / Cross Belt + Roller Brush	Deburring + Edge rounding Inside Outside	Class #1 Class #2 Class #3	Up to 100mm	laser cut and fine blanking press punch sheet metal cut parts,	Thick parts Carbon steel	LBF32-BR LBF50-BR LBF62-BR LBF50 -TNB	LBF32-BD LBF50-BD LBF62-BD

4. Valgro Classic Series



Removal of vertical burrs from laser, die and water jet cut parts. Flat parts and parts that can be placed flat. Stainless steel, steel, aluminium, copper, etc. Rough grinding of heavy-duty burrs and finishing in one pass on multi-attachment machines.

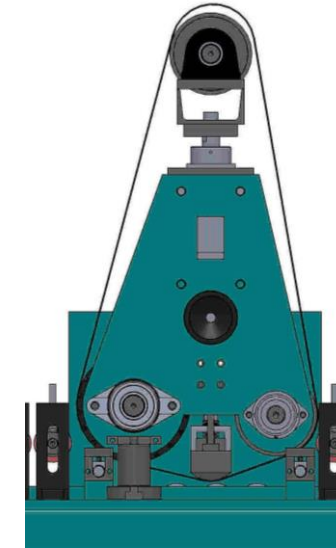

Technology	Scope Of Work	Burr Classification	Working Thickness	Material Specification	Application	Available Mode
Belt	Deburring + Grinding + Hairline Finishing	Class #1 Class #2 Class #3	Up to 100mm	Stainless steel, Aluminum, Brass, copper sheet metal parts	Laser cut & Fine Blanking for stainless steel, Aluminum	WBC 06 WBC 12 WBC 24 WBC 32 WBC 50 WBC 62

5. Valgro Classic Hybrid Series



Removal of vertical burrs from punch, laser, and water jet cut parts. Stainless steel, steel, aluminium, copper, etc. Deburring Edge breaking and surface finishing in one go using several heads. Exceptionally low operating costs and a high production capacity



Technology	Scope Of Work	Burr Classification	Working Thickness	Material Specification	Application	Available Mode
Wide Belt + Disc Brush / Belt + Roller Brush / Multi head	Grinding + Deburring + Edge Rounding + Finishing	Class #1 Class #2 Class #3	Up to 100mm	Carbon steel, Stainless steel and aluminum sheet metal parts	Laser, Plasma cut & Press punch	HYB-06 HYB-12 HYB-32 HYB-50 HYB-62

6. Valgro De-Slugger – Dross Removal



Two Belt + Brush

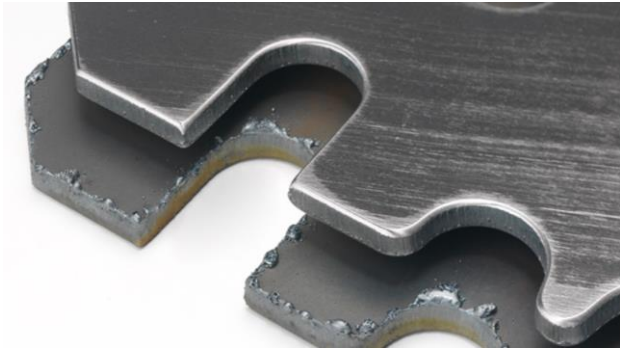
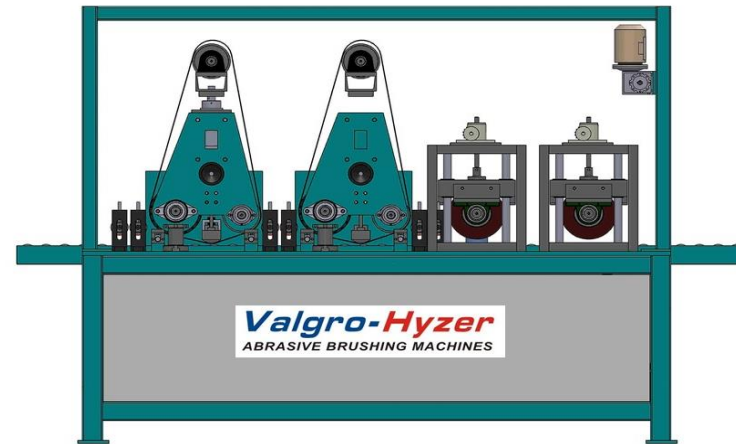

Valgro India Dross removal machine with high speed abrasive belt drum sander with multi-head deburring station offer fine surface with in and outside of the hole and corner with edge radiusing

	Technology	Scope Of Work	Burr Classification	Working Thickness	Material Specification	Available Model
	Wide Belt + Disc Brush Multi Head	slag / dross removal + Deburring + Edge Rounding	Class #1 Class #2 Class #3 Class #4	Up to 100mm	Hot Roll Carbon Steel parts	SLR-32 SLR-50 SLR-62

7. Valgro Workstation (LBF)



Ideal for cabinets - Enclosure Panels, Fabrication, Home and Kitchen Appliance Industries. Flat Surface of big dimensions, finishing of sheet, Laser, and waterjet cut parts, Square and rectangle tube, Flat products, Tubular Structures, Corners, Edge or removing welding from the surface.

Model	Technology	Scope Of Work	Burr Classification	Working Thickness	Material Specification	Available Mode
Long belt Sander Work sander	Cross Belt	Sanding + Finishing + Deburring + Finishing	Class #1 Class #2 Class #3 Weld Join remove	Up to 300mm	Stainless steel, Aluminum, sheet metal parts	WS-50 ECO WS-50 PRO WS-62 PRO WS-80 Pro Customize

8. Valgro Edge deburring – Side wall – Auto Feed

Designed to remove metal burrs from sheet external perimeter. Burr formation happens after cutting processes such as shearing, punching - **Removal Nib & Micro Joint** Shearing cut, Top and Side wall both in one pass



- No physical strain
- Avoid unhealthy position
- Employee do not have to suffer under flying spark, dust, dirt or noise.

Name	Technology	Scope Of Work	Burr Classification	Working Thickness	Material Specification	Available Mode
Klean Burr	Deburring wheel / Disc	Deburring + Finishing + Cleaning	Class #1 Class #2	0.8mm - 12mm	sheet metal parts	EDG-11 EDG-21

9. Valgro End Edge deburring – Side wall – Manual Feed



Designed to remove metal burrs from sheet external perimeter. Burr formation happens after cutting processes such as shearing, punching

Removal **Nib & Micro Joint**
Shearing cut,

Name	Technology	Scope Of Work	Burr Classification	Working Thickness	Material Specification	Available Mode
Klean Burr	Deburring wheel / Disc	Deburring + Finishing + Cleaning	Class #1 Class #2	0.8mm - 12mm	sheet metal parts	EDG-09

10. Valgro End Edge Deburring



Designed to remove metal burrs and shear cut edge from ends of pipes, tubes, and profiles



Name	Technology	Scope Of Work	Burr Classification	Working Thickness	Material Specification	Available Mode
Klean Burr	Disc Brush	Deburring + Edge radius	Burr Class #1, #2 & #3	Up to 100mm	Cut parts like, heatsink, Profile, tube, Aluminum, Stainless steel carbon steel	EED-14 M EED-14 A EED-14 BE Custom made

11. Valgro Handheld deburring Machine



- Portable mobile polisher for small part deburring and finishing after laser cut, as well as suitable for stainless steel fabrication shop

	Technology	Scope Of Work	Burr Classification	Working Thickness	Material Specification	Available Mode
Valgro	Belt + Roller Brush	Deburring + Finishing + Cleaning	Class #1 Class #2	0.8mm - 3mm	Stainless steel, Aluminum, Brass, copper sheet metal parts	DB24E, DB24HD, DB32E, DB32HD, DB50HD, DB62HD

Flexible Solution Custom Made Design

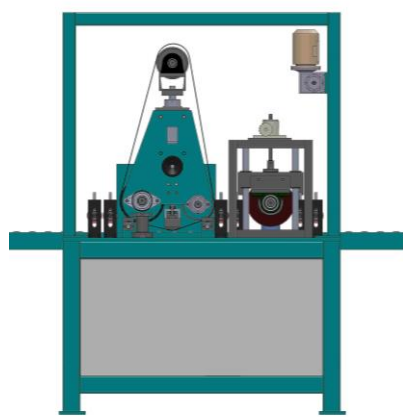

Wide Belt + Brush

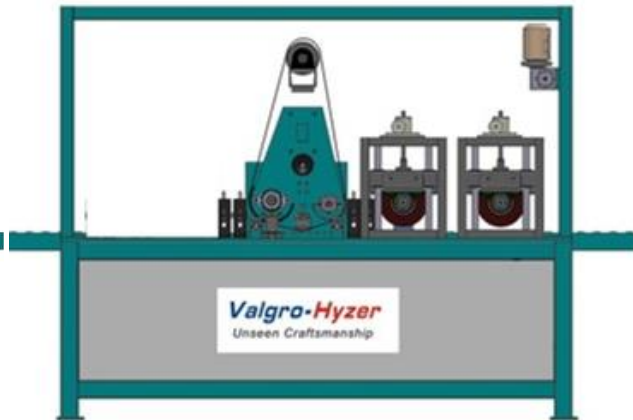

Wide Belt + Brush + Brush

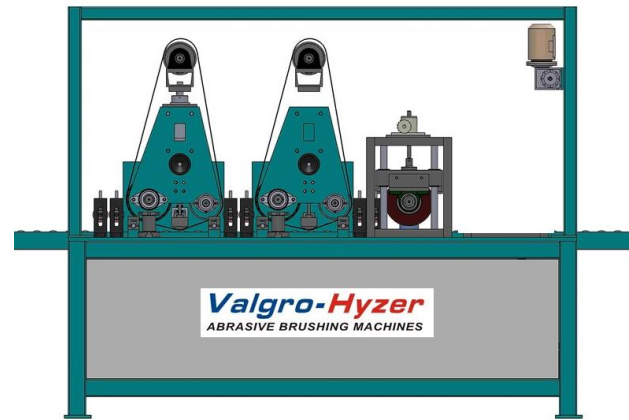

Wide Belt + Belt + Brush

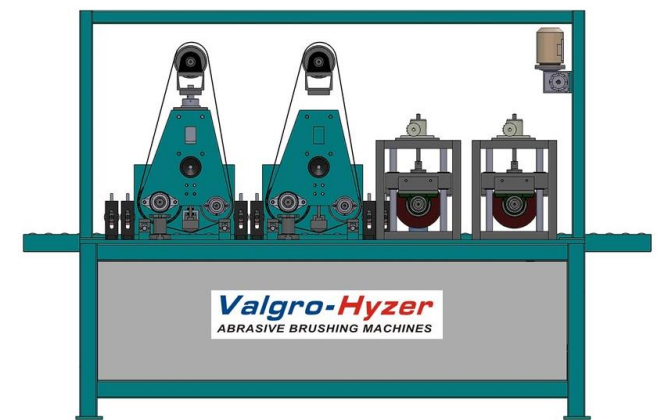

Wide Belt + Belt + Brush + Brush

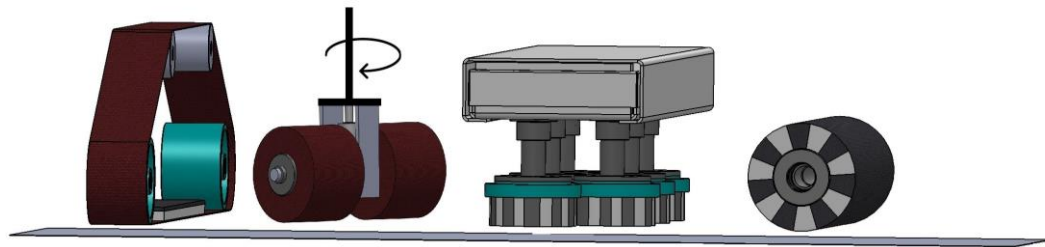

Multi Station Deburring Machine

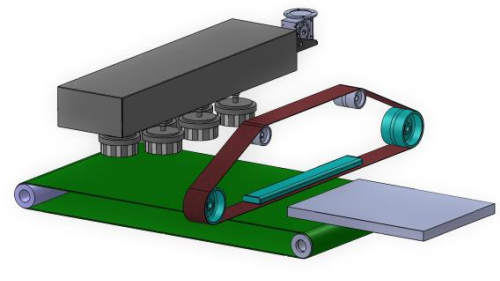

Cross Belt + Brush

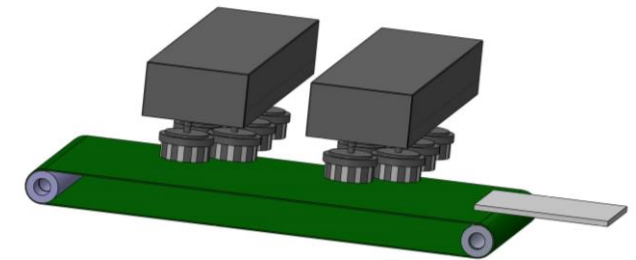

(Disc) Brush + Brush

Perfect Edge and Surface finishing from Valgro Abrasives



Test your own products

in our experience centre

with

Minimum Investment



VALGRO INDIA LIMITED

www.brushingmachine.com

www.brushingmachine.com

www.ecopickledsurface.com

www.valgroabrasives.com

www.valgro.co.in

www.youtube.com/valgroabrasives



P2 BrighteX™
Eco Pickling & Passivation Gel



Valgro-Hyzer
Xpert in metal preparation

Duklean
Clean Air Equipment, s
Valgro

Valgro-Fynex™
superlative surface solutions



Valgro India Limited
Ahmedabad, Gujarat
India

sales@valgroabrasives.com